

Article number: 2033100M1250B1X
 Description: E+G levelling foot
 GN 33-100-M12-50-B1-X, Stainless steel
 Note: X With female thread, External hexagon

Measures

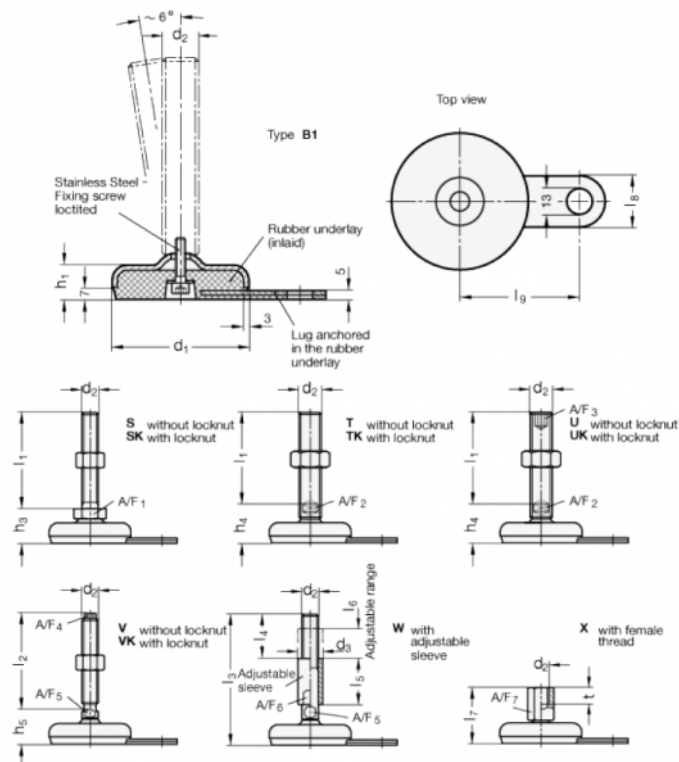

- A/F7 = 17
- d1 = 100
- d2 = M12
- h1 = 21
- l7 = 50
- l8 = 30
- l9 = 80
- t = 12